

MARITIME ANTENNA

Maritime 40G

Overview

- Designed for Maritime Applications**
 IP68 rated, durable and UV-stable housing an omnidirectional antenna for the best signal reception.
- Designed for 5G**
 Optimal gain, 4x4 MIMO antenna configuration for the best performance for maritime installations.
- Ultra-wide bandwidth**
 Wide frequency range (410-6000MHz) for supporting LTE and 5G connectivity.
- Easy installation**
 Supports standard maritime 1" 14 TPI thread mount and also has an L-shape mount for non-standard installations.
- Wi-Fi bands**
 The antenna is designed for cellular bands but also covers both 2.4 & 5GHz Wi-Fi frequencies. To use the antennas for Wi-Fi, you will require an SMA to RP-SMA adapter.

Applications

- Maritime

7
dBi

IP
68

4x4
MIMO

↑↓
LTE

📍
GPS

Built
for
5G

TAA 
COMPLIANT

Specification

Cellular

Antenna elements	4 elements
Cellular frequency bands & Gain	3.2dBi: 410-470MHz 3.8dBi: 617-960MHz 5.3dBi: 1710-2700MHz 6.5dBi: 3400-4200MHz 6.7dBi: 4900-6000MHz
VSWR	<3.5: 410-470MHz <3.0: 617-960MHz <2.5: 1710-6000MHz
Max feed power handling	10W
Input impedance	50 Ω
Polarisation	Linear

GPS

Frequency range	1561-1602 MHz
Peak gain	0.5dBi@1575MHz 1.6dBi@1602MHz
VSWR	< 2.5
Output return loss	10dB max
LNA gain	28 ±3dB
Noise figure	1.5dB max at 3.3V
Operating Voltage	3.3V
Power consumption	8.5mA ±2.5m at 3.3V

Cable (LTE/5G)

Type	CFD-200
Length	6'7" / 2m
Loss	0.33 dB/m @ 900 MHz 0.49 dB/m @ 2000 MHz 0.55 dB/m @ 2500 MHz 0.87 dB/m @ 5800 MHz
Diameter	13/64" / 5.0mm
Jacket	Half matt PVC, UV resistant
Termination	SMA male

Cable (GPS)

Type	RG-174
Length	6'7" / 2m
Loss	3.4 dB/m @ 1000 MHz 4.9 dB/m @ 1800 MHz
Diameter	0.1" / 2.7mm
Jacket	Half matt PVC, UV resistant
Termination	SMA male

Specifications subject to change without notice.

Maritime 40G

Mounting

Supported types	Standard Maritime 1" 14 TPI thread Pole and wall mounting Pole diameter: 1-2" (25-50mm)
-----------------	---

Mechanical

Product dimensions (Diameter) (Height)	3.78" / 96mm 34.39" / 873.5mm
Packaged dimensions	41.54" x 6.0" x 6.1" 1055 x 153 x 155mm
Housing material	UV stable PC

Package contents

Antenna	Maritime Antenna 40G
Accessories	Maritime mount set L-shape mount set Deck mount (ACW-652)

Environmental & Compliance

IP rating	IP68
Operating temperature	-40° - 176°F / -40° - 80°C
Storage temperature	-40° - 176°F / -40° - 80°C
Compliance	ROHS, REACH, WEEE
Wind survivability	100mph / 160km/h
Salt Spray	MIL-STD 810F/ASTM B117

Contact Us

maritime@peplink.com

Find a Peplink Certified Partner

<https://www.peplink.com/peplink-certified-partners/>

Ordering Information

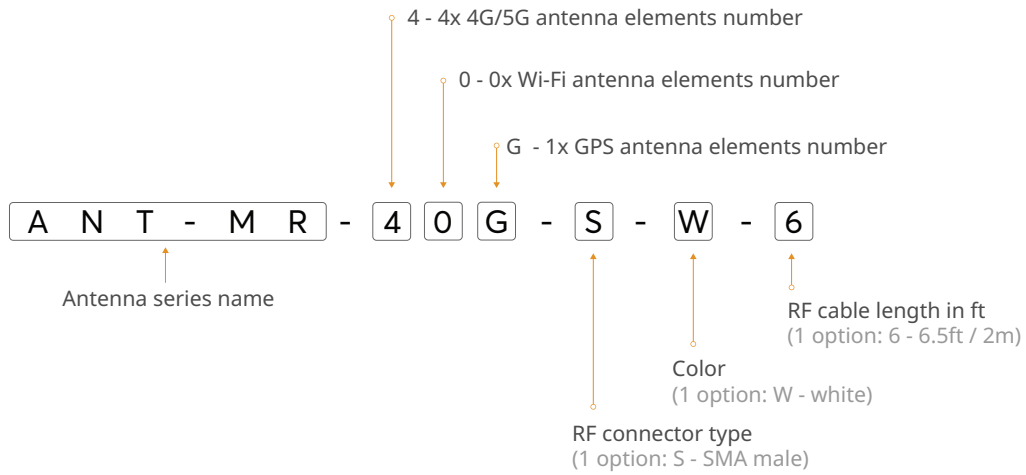

Product Code

ANT-MR-40G-S-W-6

Description

4x LTE/5G, 1x GPS 410-6000MHz, IP68, SMA male, White, 6.5ft / 2m



Technical Drawing



ACW-652

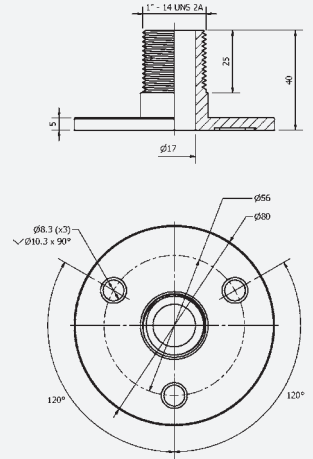

Mechanical Specification

Material	Stainless Steel SS316
External thread	1" 14 TPI
Dimensions HxD	1.57" x 3.15" (40 x 80mm)
Weight	250g / 0.55 pounds

Cellular Antenna VSWR

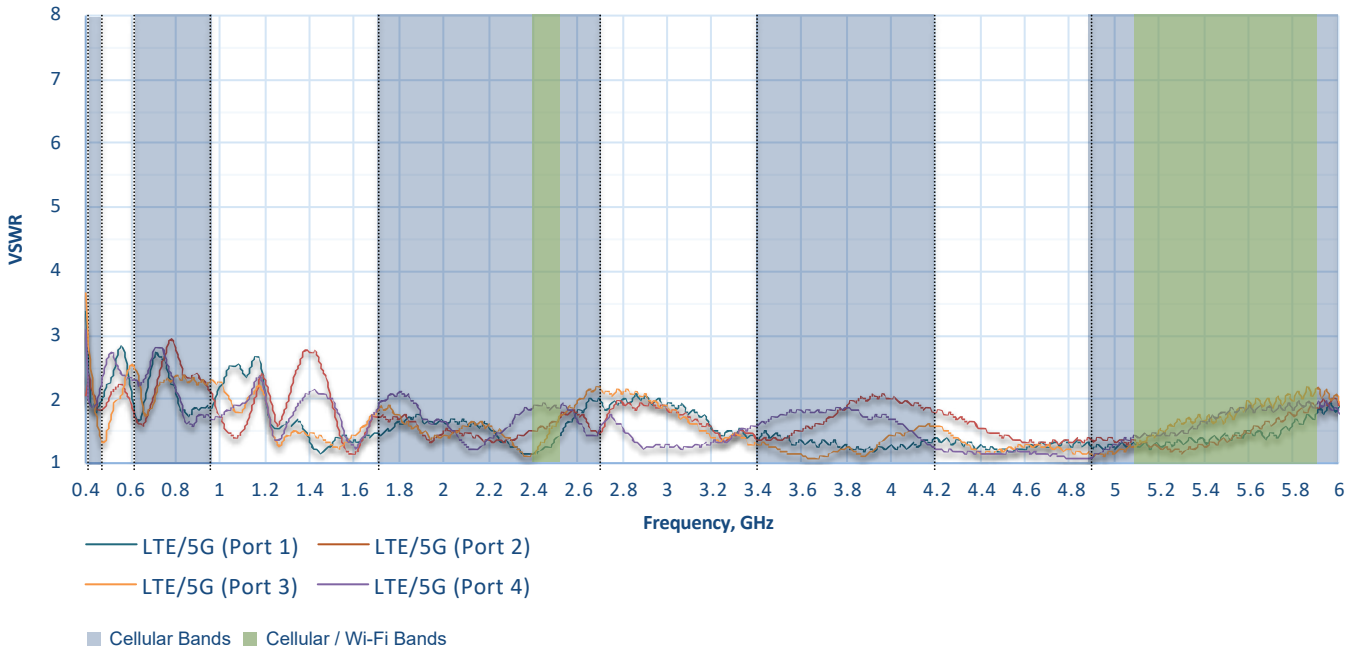

Cellular Antenna Element Isolation

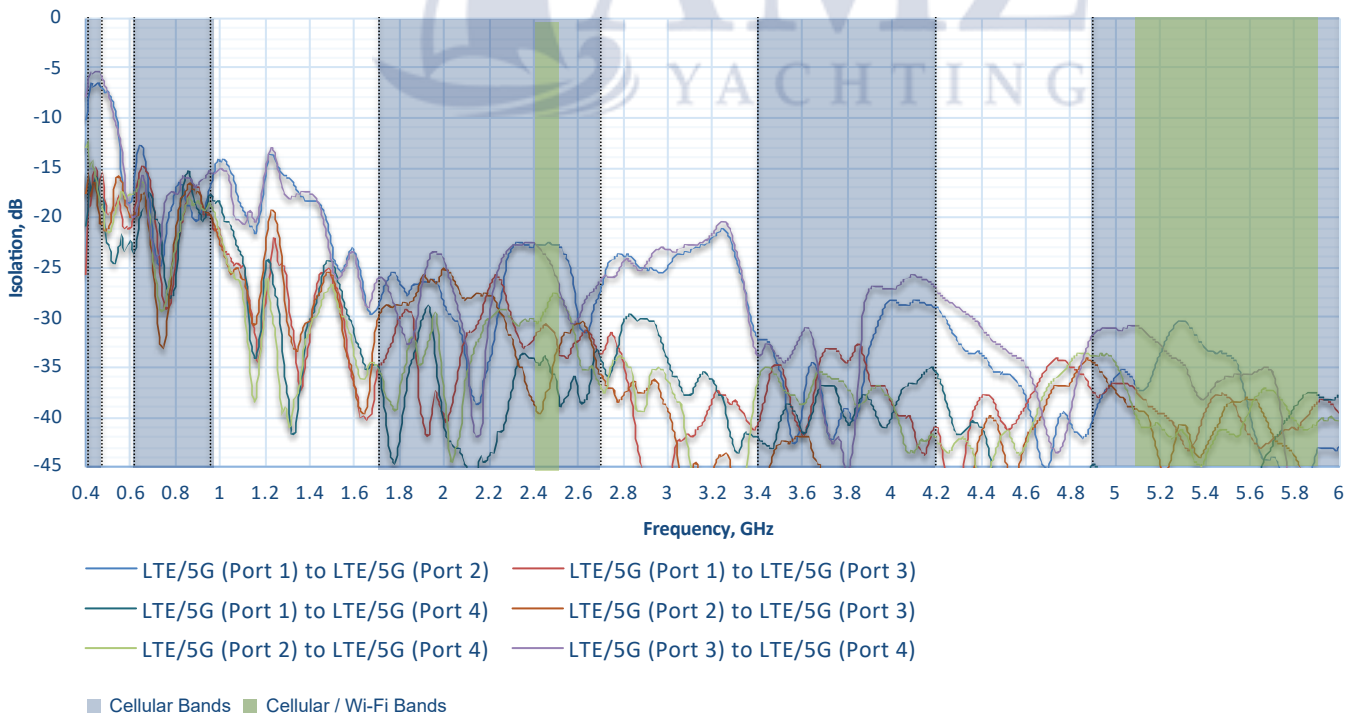

Cellular Antenna Gain

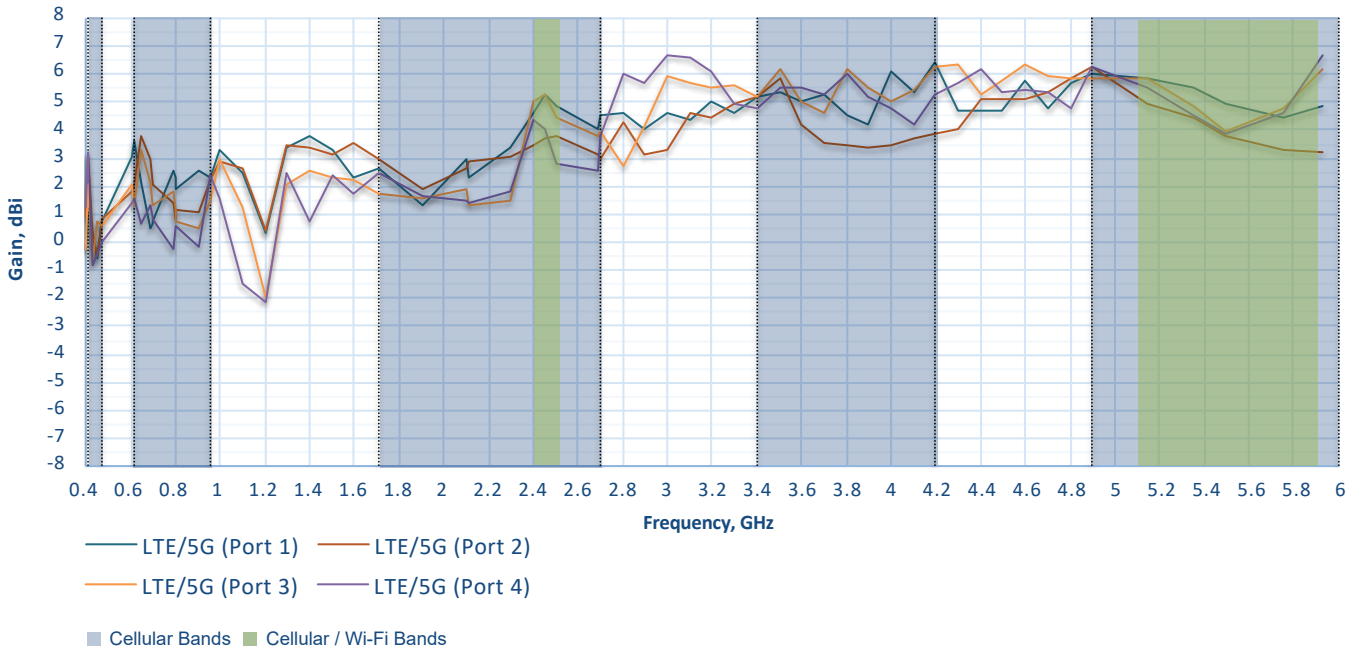

Cellular Antenna Efficiency

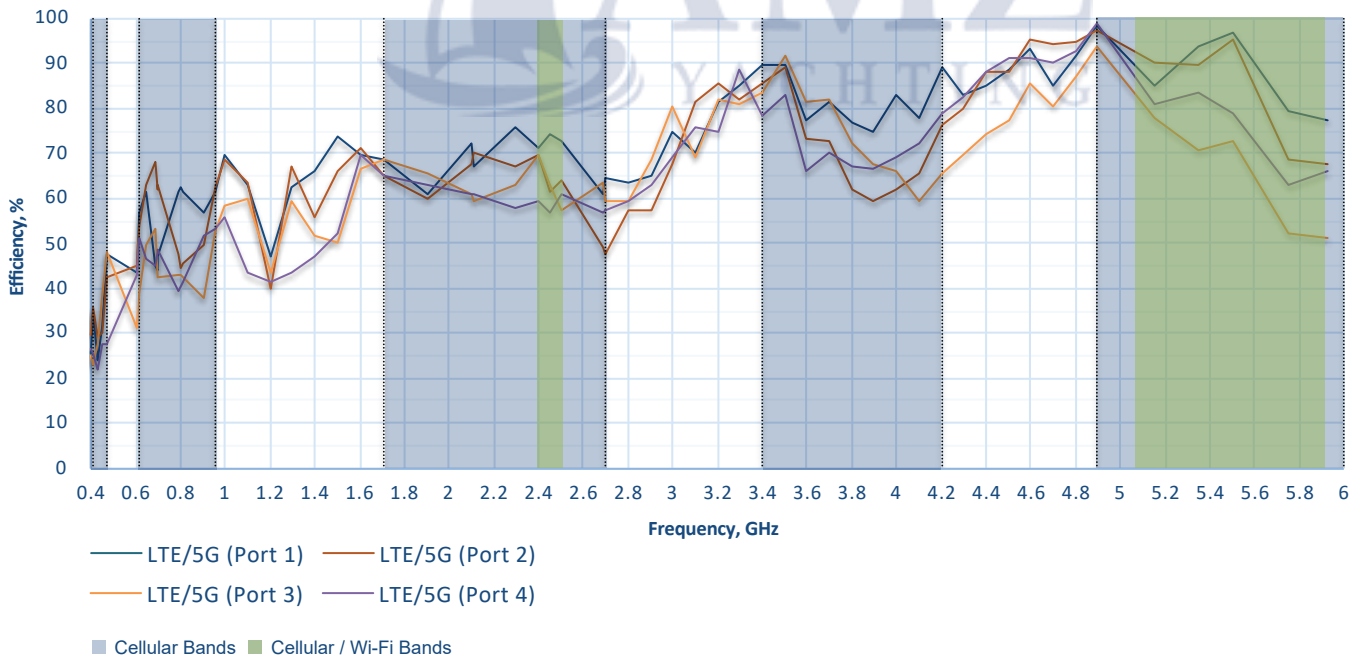

Radiation Patterns (Azimuth)

430-960 MHz

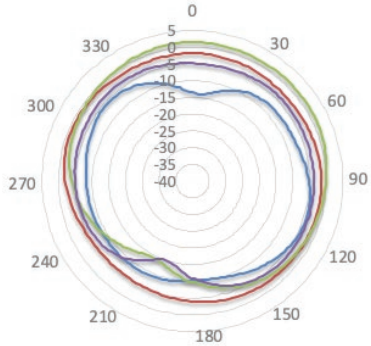

— 430MHz — 617MHz — 800MHz — 960MHz

3400-3800 MHz

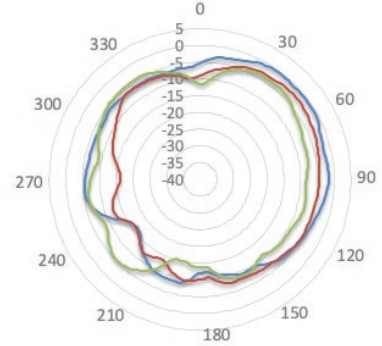

— 3400MHz — 3600MHz — 3800MHz

1710-2100 MHz

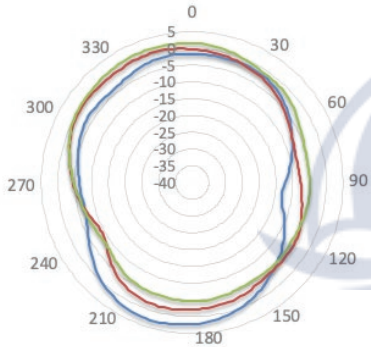

— 1710MHz — 1900MHz — 2100MHz

4200-5150 MHz

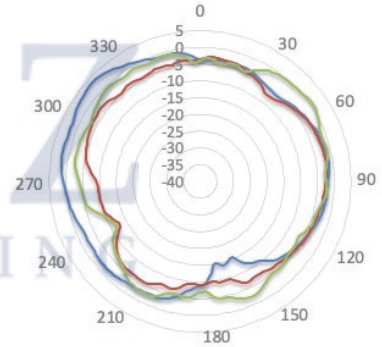

— 4200MHz — 4900MHz — 5150MHz

2300-2700 MHz

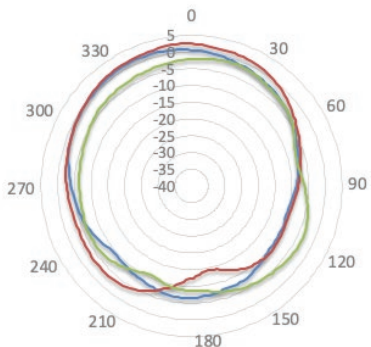

— 2300MHz — 2500MHz — 2700MHz

5350-5930 MHz

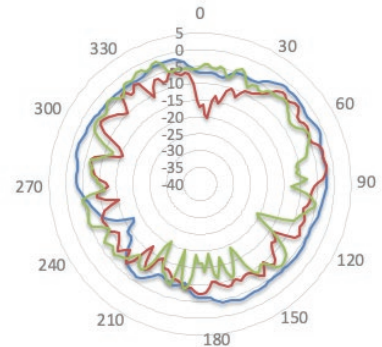

— 5350MHz — 5750MHz — 5930MHz

Maritime 40G

Radiation Patterns (Elevation 1)

430-960 MHz

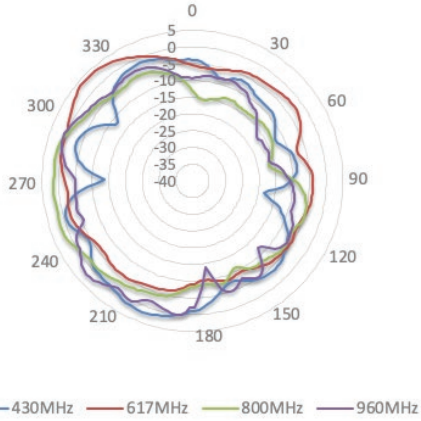

3400-3800 MHz

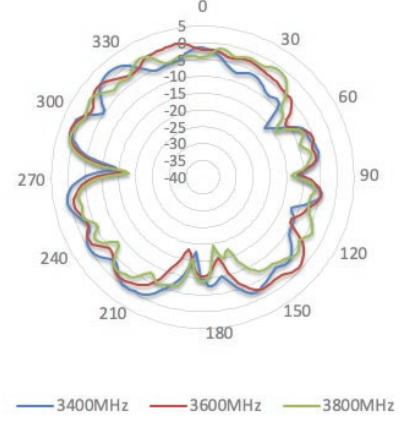

1710-2100 MHz

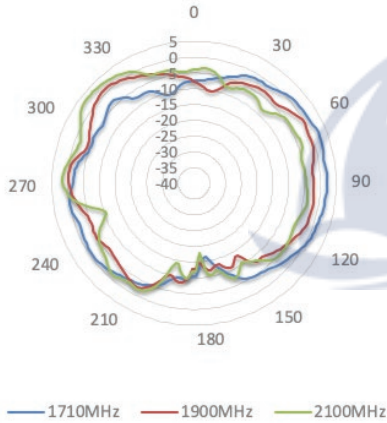

4200-5150 MHz

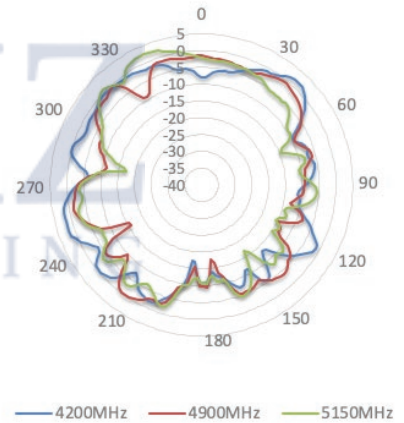

2300-2700 MHz

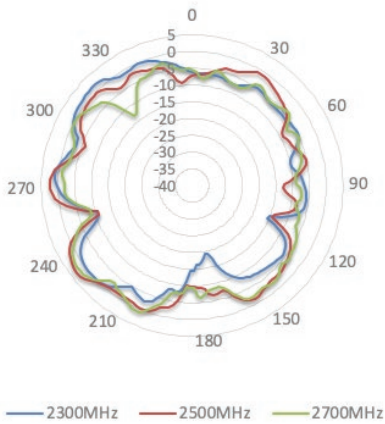

5350-5930 MHz

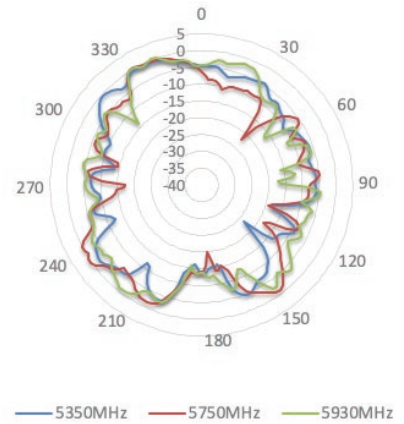

Maritime 40G

Radiation Patterns (Elevation 2)

430-960 MHz

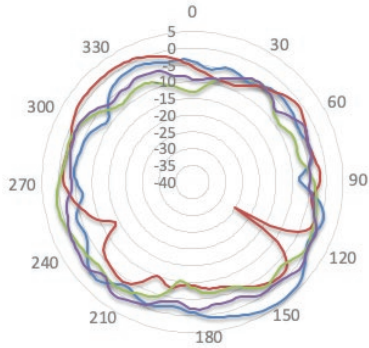

— 430MHz — 617MHz — 800MHz — 960MHz

3400-3800 MHz

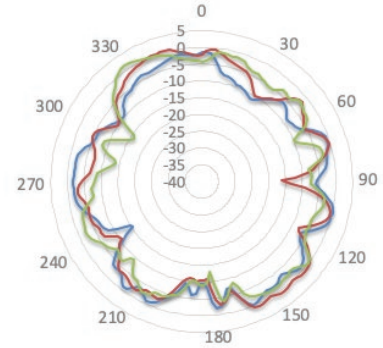

— 3400MHz — 3600MHz — 3800MHz

1710-2100 MHz

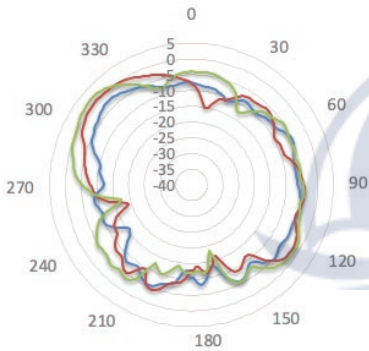

— 1710MHz — 1900MHz — 2100MHz

4200-5150 MHz

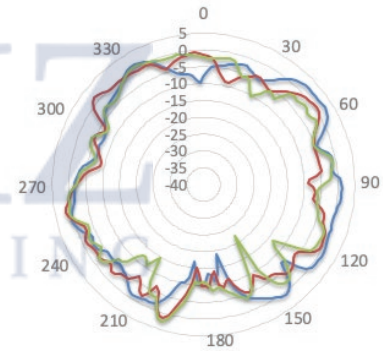

— 4200MHz — 4900MHz — 5150MHz

2300-2700 MHz

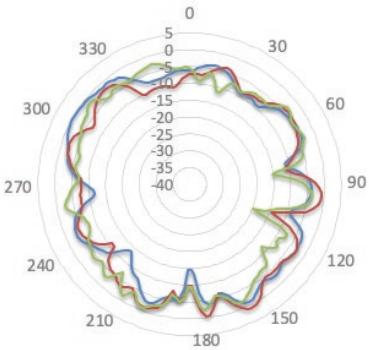

— 2300MHz — 2500MHz — 2700MHz

5350-5930 MHz

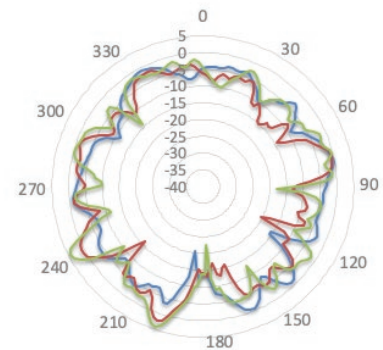

— 5350MHz — 5750MHz — 5930MHz

Maritime 40G

Installation Recommendation

Maritime Mount (cable inside)

Maritime 40G

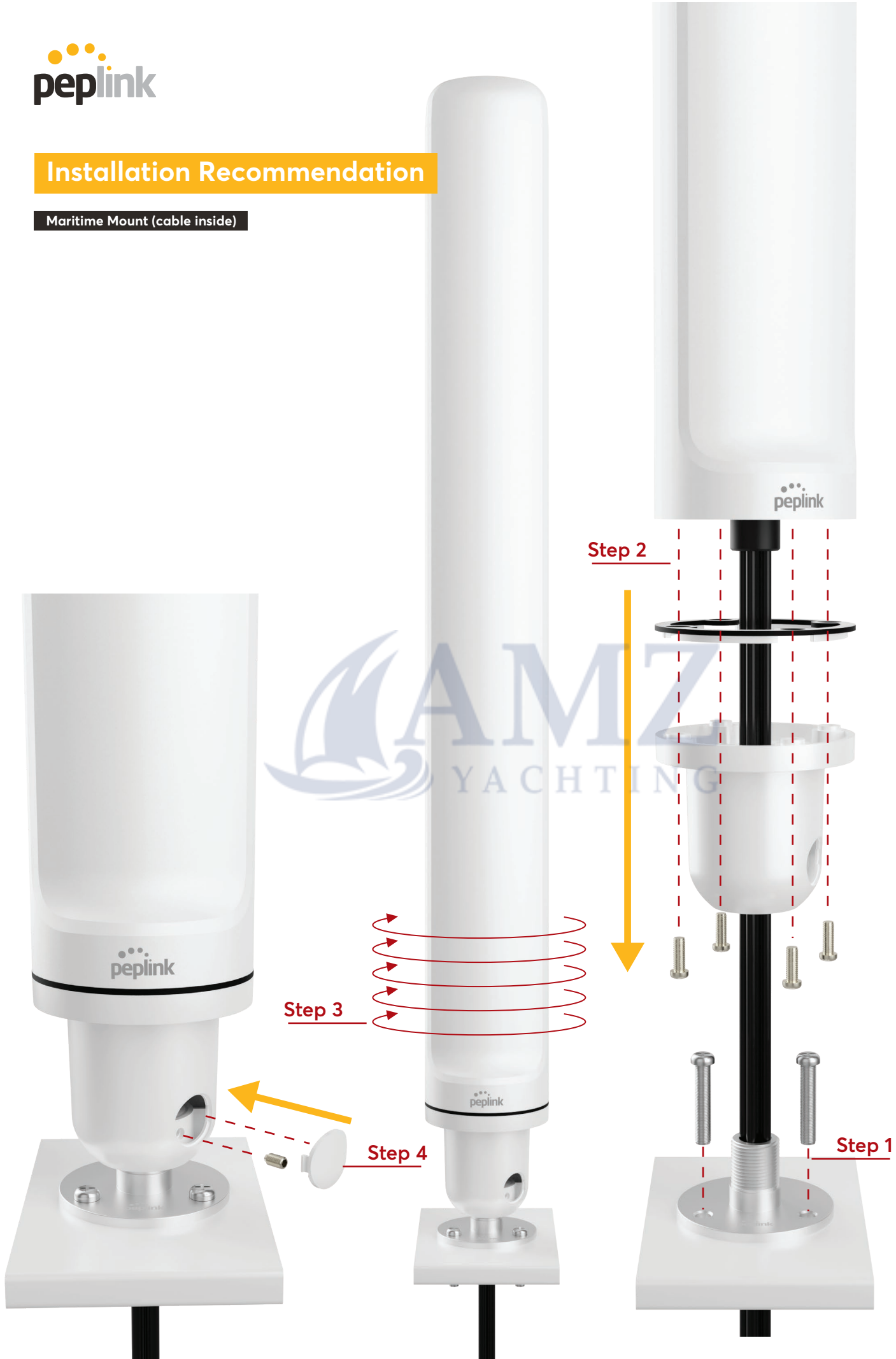

Installation Recommendation

Maritime Mount (cable outside)

Maritime 40G



Step 4



Step 5



Step 2



Step 3

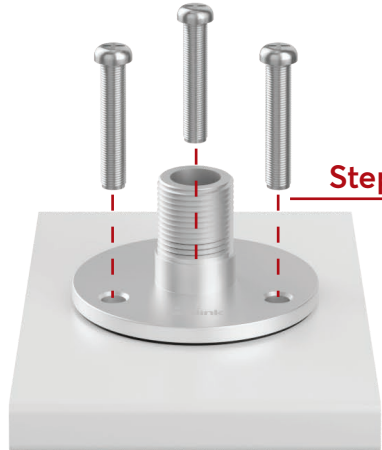

Step 1

Installation Recommendation

L-shape Mount (horizontal pole)



Maritime 40G

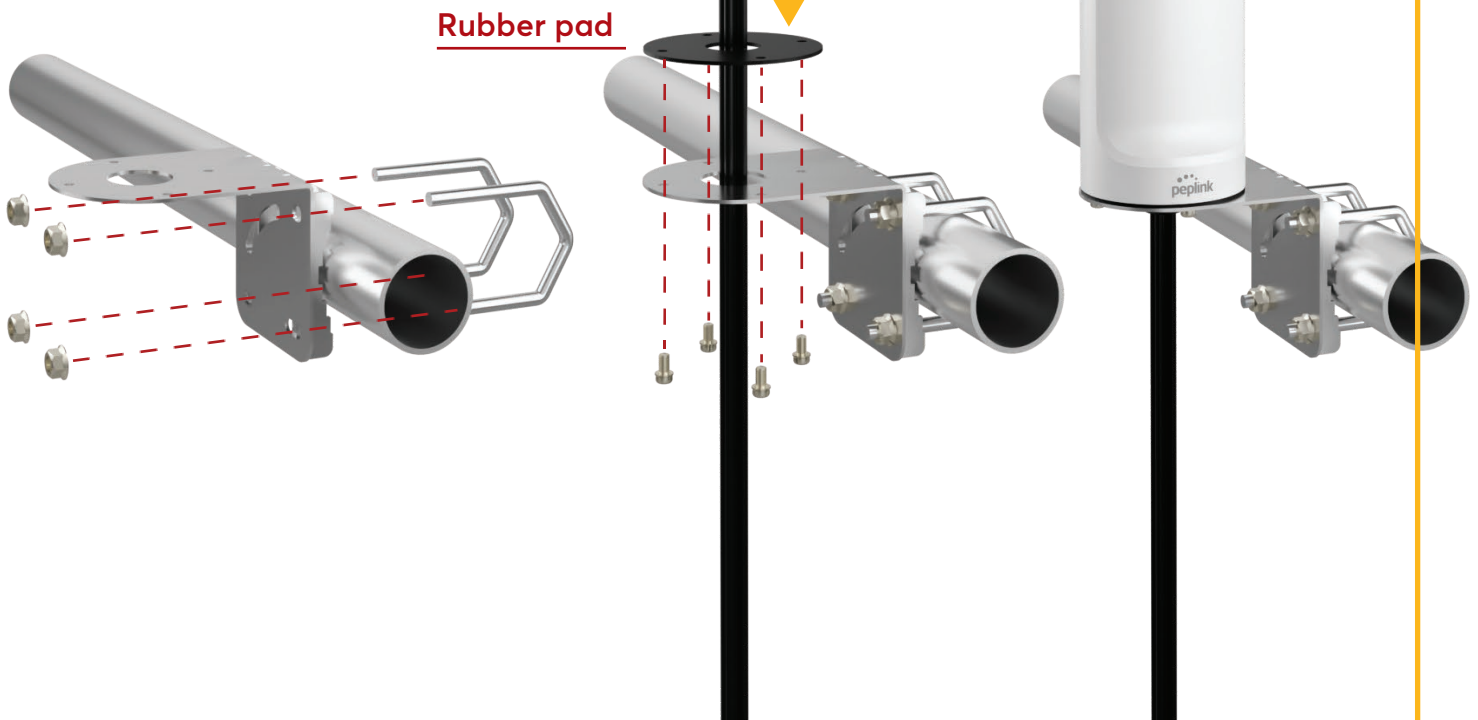

Installation Recommendation

L-shape Mount (vertical pole)

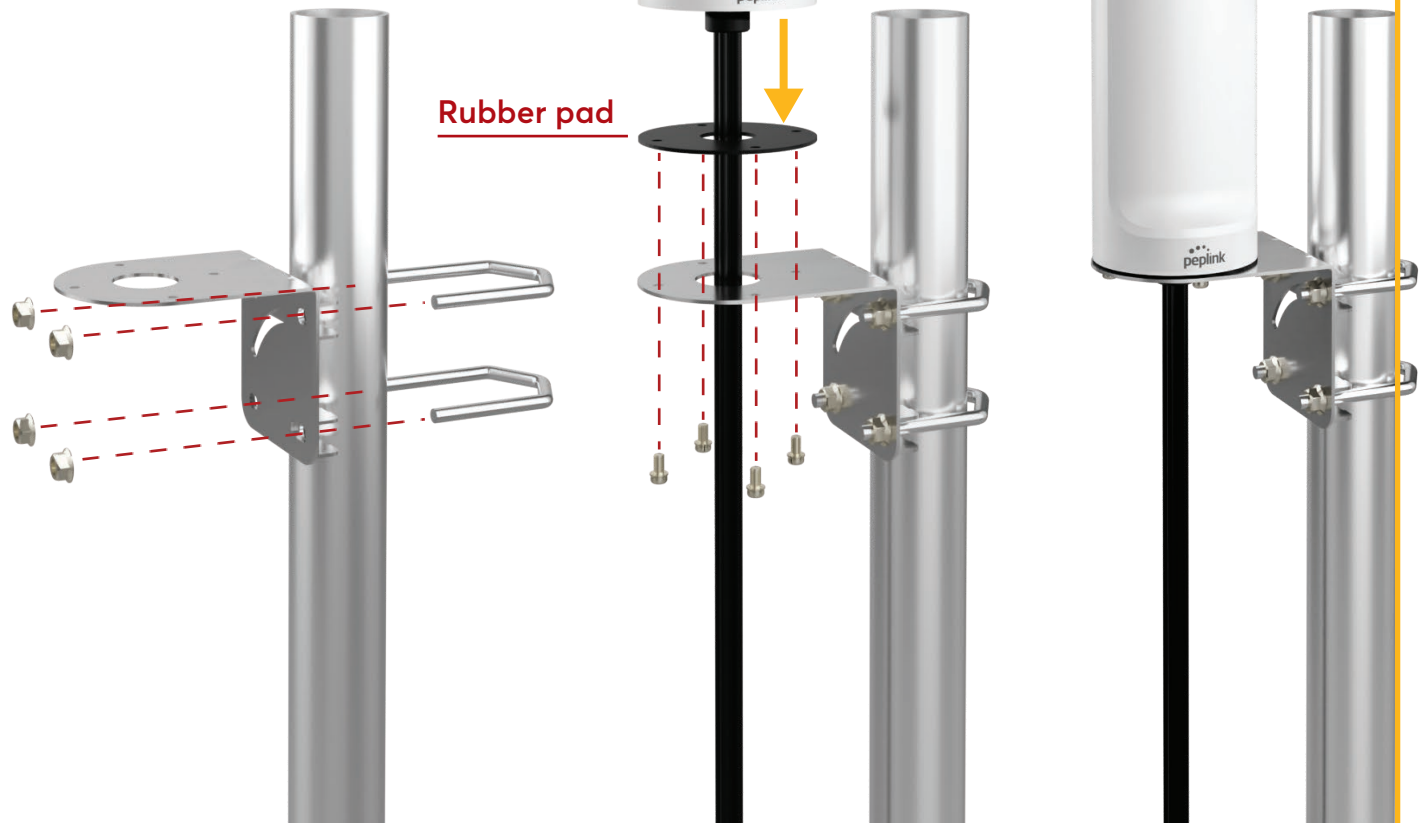

Maritime 40G

Packing List Information

Antenna

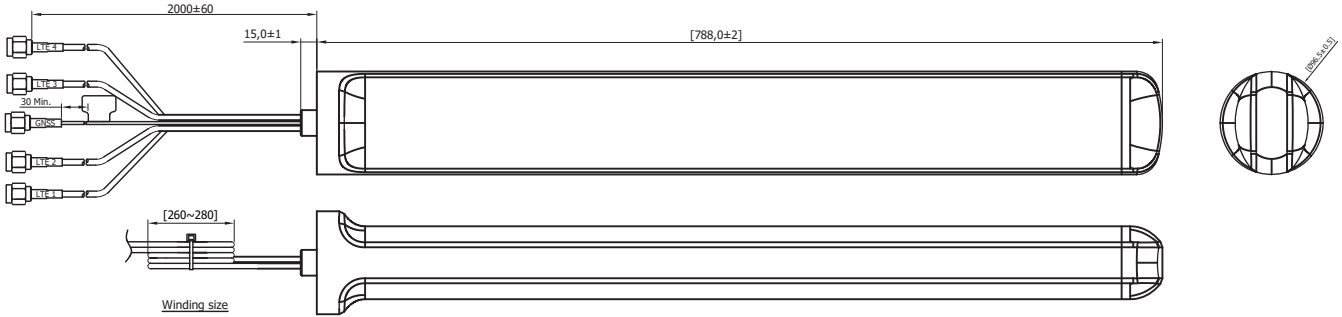

Maritime Mount Set

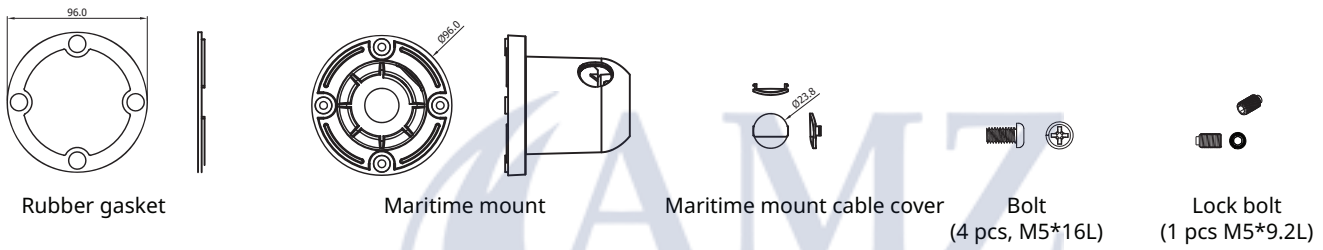

Deck Mount Set

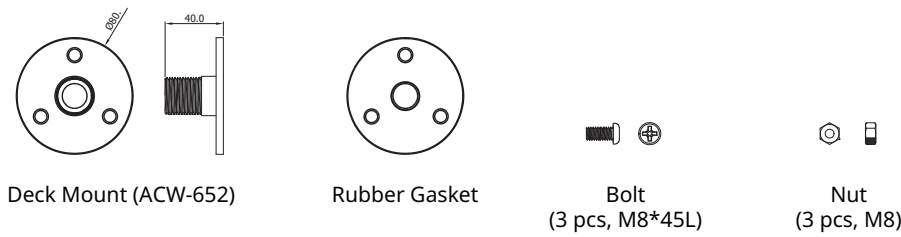

L-Mount Set

